



TECHNICAL DATA SHEET

18" CAST-IN-PLACE ROOFTOP ANCHOR

RC180806

AXIS
ANCHOR PRODUCTS

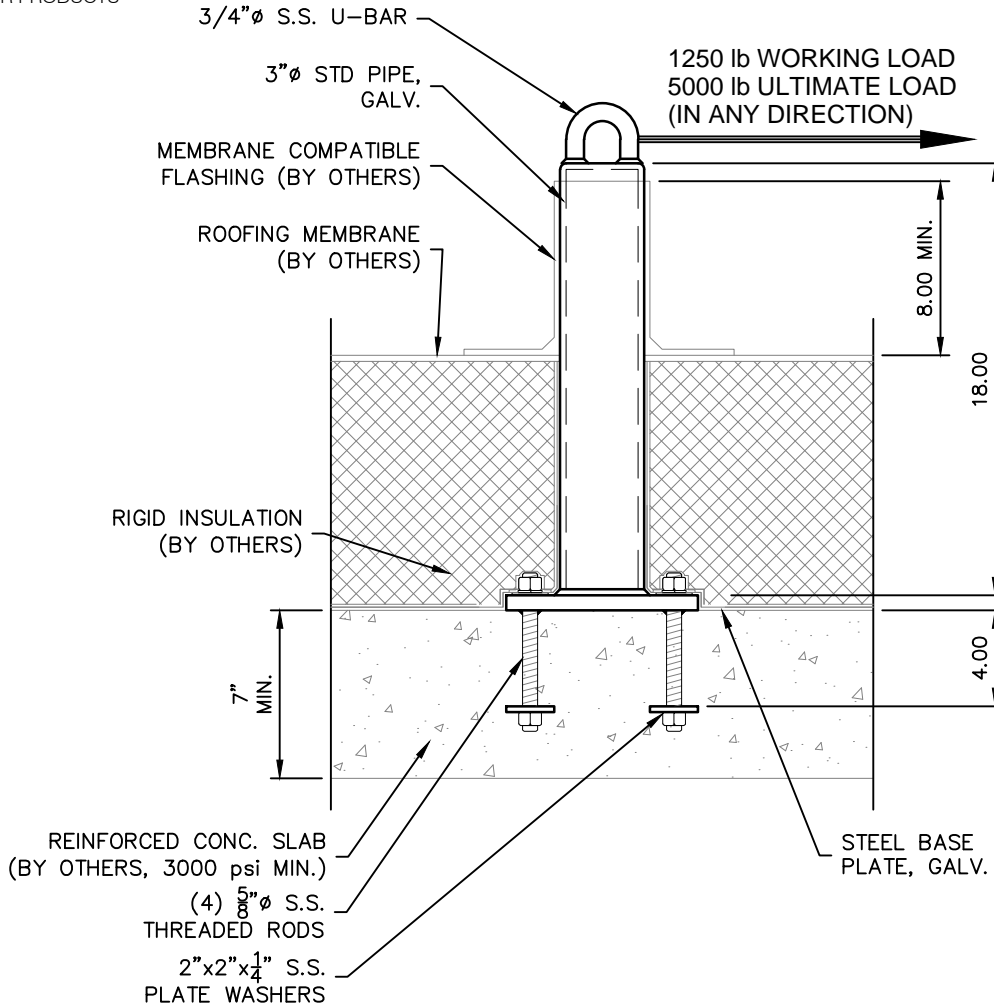

NOTES:

1. THE PROJECT STRUCTURAL ENGINEER IS RESPONSIBLE FOR THE DESIGN OF THE BUILDING STRUCTURE AND LOCAL REINFORCEMENT WHERE REQUIRED, TO WITHSTAND THE APPLIED LOADS OF THE ROOF SAFETY EQUIPMENT SUPPLIED BY ROOFTOP ANCHOR, INC.
2. FALL ARREST SAFETY ANCHORS ARE DESIGNED TO A TYPICAL MAXIMUM FALL ARRESTING FORCE OF 1,800 lbs WHEN WEARING A BODY HARNESS, WITH A FACTOR OF SAFETY OF 2 WITHOUT ANY PERMANENT DEFORMATION; AND TO 5,000 lbs AGAINST FRACTURE OR DETACHMENT.

ROOFTOP ANCHOR

PROPRIETARY AND CONFIDENTIAL

The information contained in this drawing is the sole property of Rooftop Anchor, Inc. Any reproduction in part or as a whole without written permission of Rooftop Anchor, Inc. is prohibited.

EFFECTIVE: JANUARY 2016

